

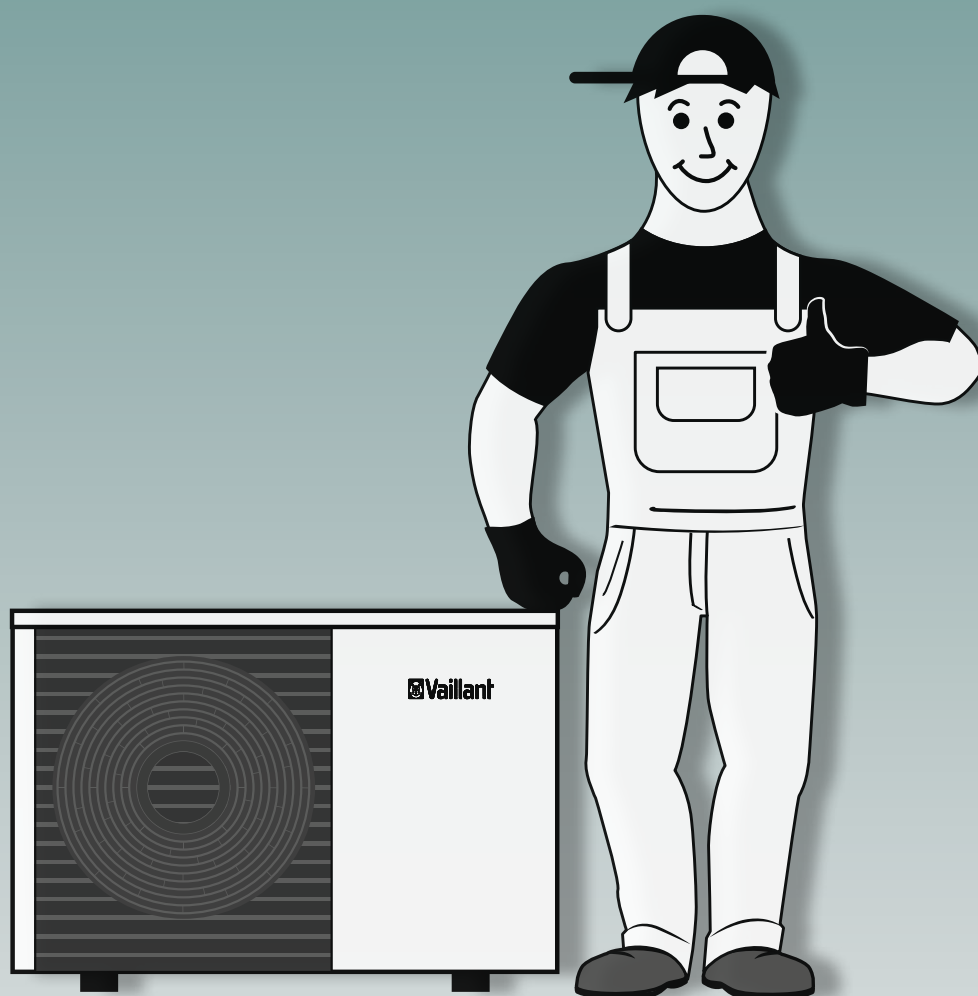

# aroTHERM plus



### **Nota importante:**

Este guia rápido tem como objetivo ajudar o instalador a planejar, instalar e efetuar o comissionamento do aparelho. Não substitui de forma alguma as instruções de instalação, operação e manutenção fornecidas com o aparelho, que devem sempre ser observadas.

O não cumprimento das instruções fornecidas com o aparelho pode causar mau funcionamento do aparelho e resultar em morte ou ferimentos graves. Algumas características do dispositivo mostradas neste guia rápido podem variar da versão mais recente da série. A Vaillant não se responsabiliza por quaisquer danos ou ferimentos resultantes direta ou indiretamente do uso deste guia rápido.

©Todos os direitos reservados, Vaillant GmbH, 2019

### **Nota:**

Clique no símbolo para documentos específicos para obter informações mais detalhadas.



### **Nota:**

Digitalize o código QR para baixar a versão digital do Guia Rápido.





# Vamos começar!

## Rumo à instalação perfeita passo-a-passo.

---

### Planeamento do seu trabalho ...

- » Selecione a aroTHERM plus ideal para suprir as suas necessidades de: performance, dimensões, nível sonoro. 4
- » Encontre o espaço perfeito para a sua instalação: silencioso, ventilado e seguro 7
- » Selecione o sistema de acumulação perfeito de água quente sanitária e o seu buffer 11
- » Dimensione o vaso de expansão 12
- » Selecione o esquema do seu sistema (componentes, sistema hidráulico) 13
- » Escolha o tipo de instalação para seleccionar os acessórios necessários 14
- » Utilize o seu check-list de planeamento  17

### ... Instale o seu sistema com aroTHERM plus

- » Comece com a conexão hidráulica 18
- » Continue com a fonte de alimentação e a conexão eBUS 19
- » Conecte a torre hidráulica ou módulo mural 21
- » Utilize o seu check-list de instalação  24

### ... e inicie o seu sistema

- » Siga as instruções do assistente de instalação 25
- » Encontre informações para códigos de erro, mensagens de estado e manutenção 25

Consulte os manuais de instalação para mais informação.

---

Nós estamos aqui para ajudar!

Não hesite em nos contatar para mais suporte:



# Planeamento do seu trabalho ...

## Aquecimento

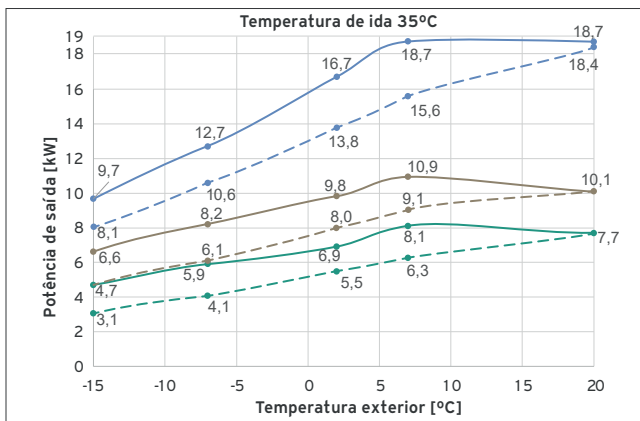

—●— VWL 45/6 S3 —●— VWL 65/6 S3 —●— VWL 125/6 (230 V/400 V) S3  
—●— VWL 55/6 S3 —●— VWL 85/6 S3 —●— VWL 155/6 (230 V/400 V) S3

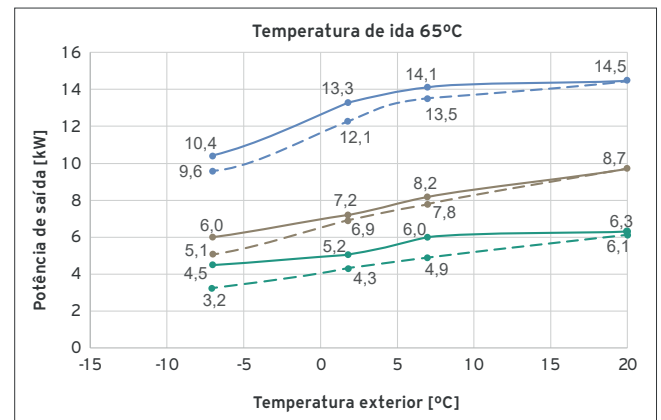
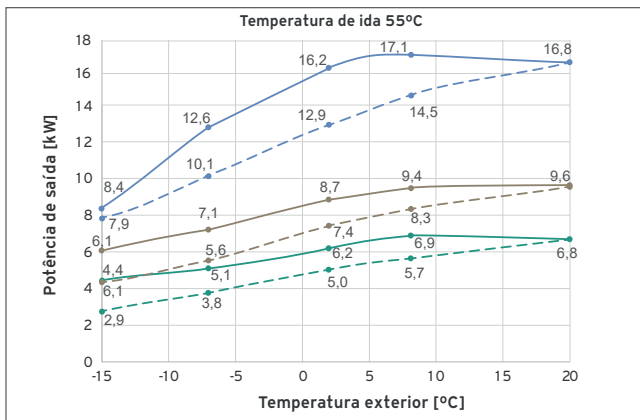
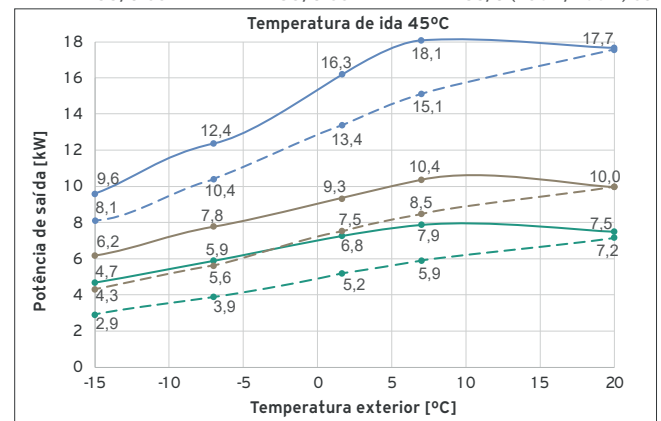

## Arrefecimento

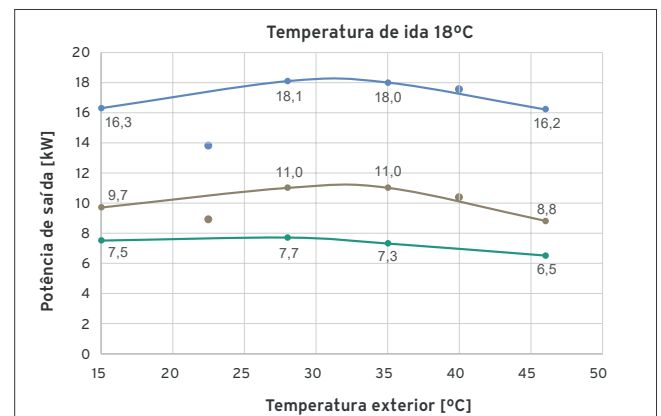
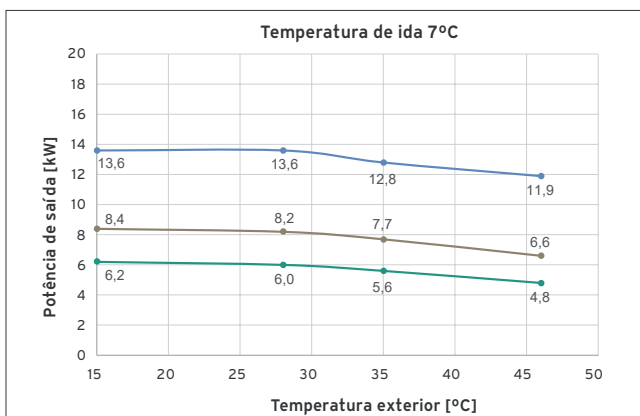

## Dimensões do produto

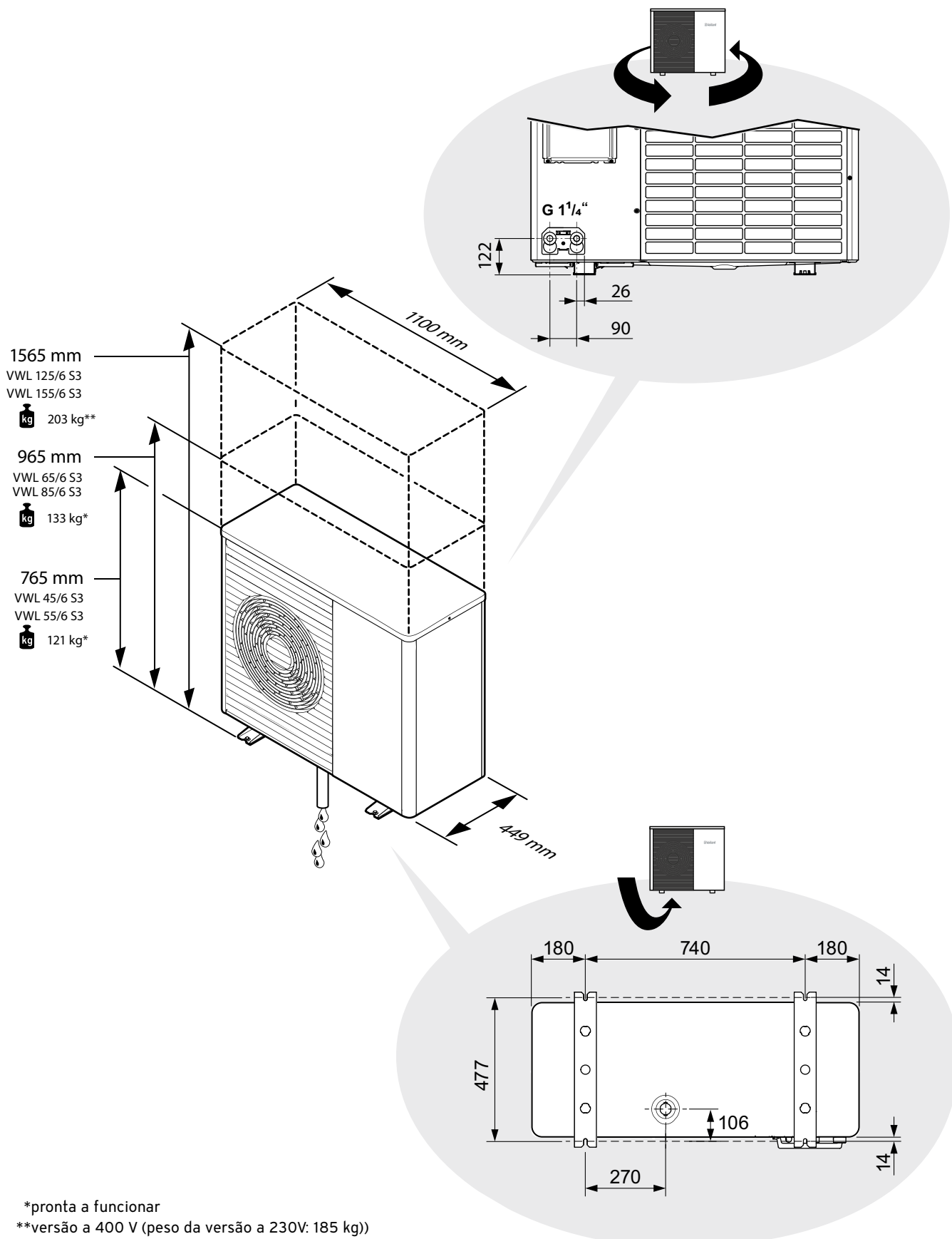

## Nível de pressão sonora

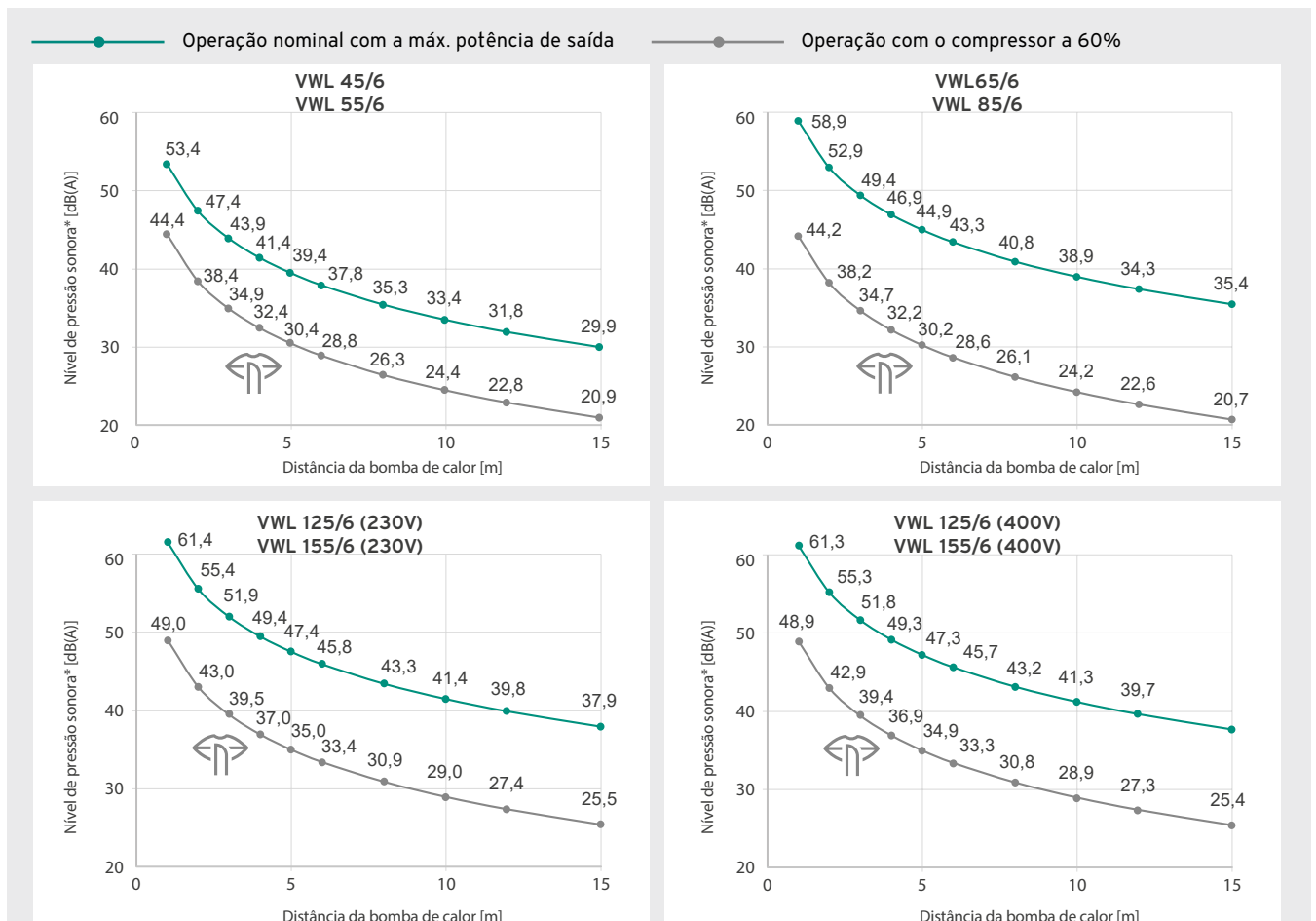

\* Nível de pressão sonora aplicável nas seguintes situações:

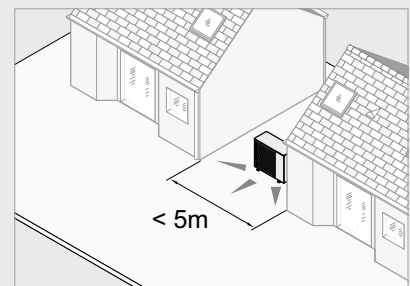
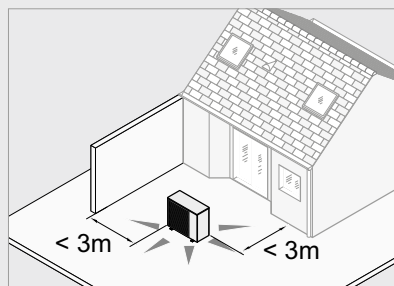
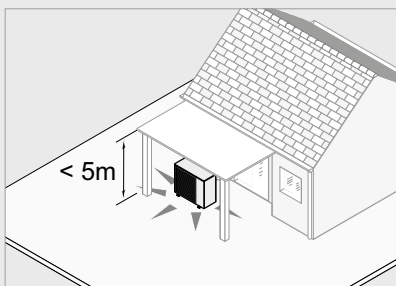

... este nível é **reduzido** conforme:

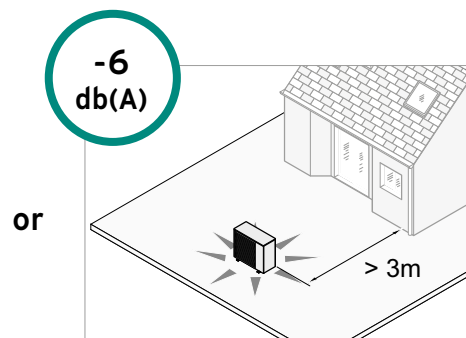
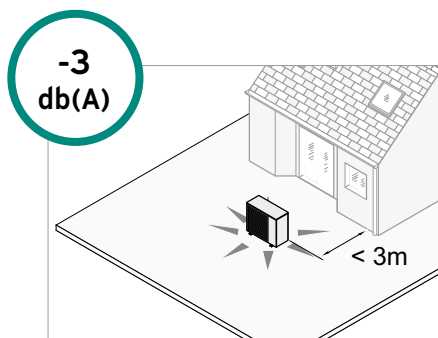

or



0020222099



# Encontre o local perfeito para a sua instalação

## Um local tranquilo para a sua instalação

Sim! 

Não! 

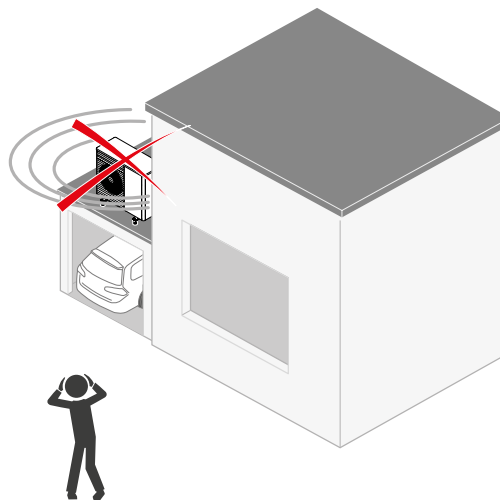
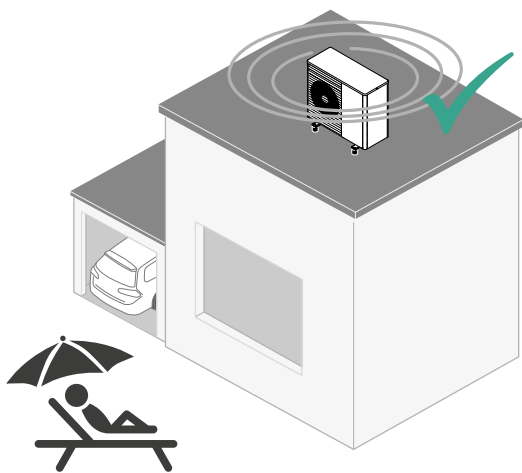
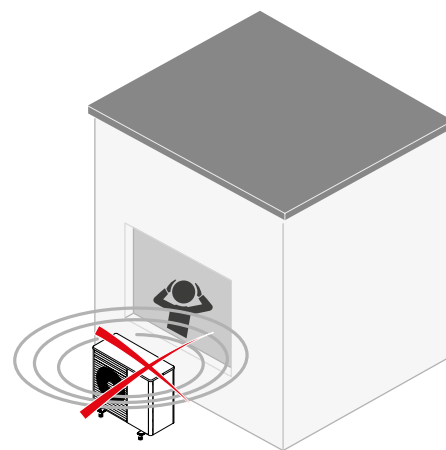
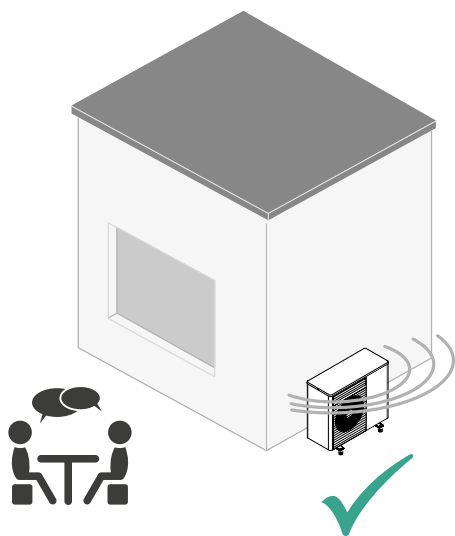

## Um local seguro para um funcionamento perfeito

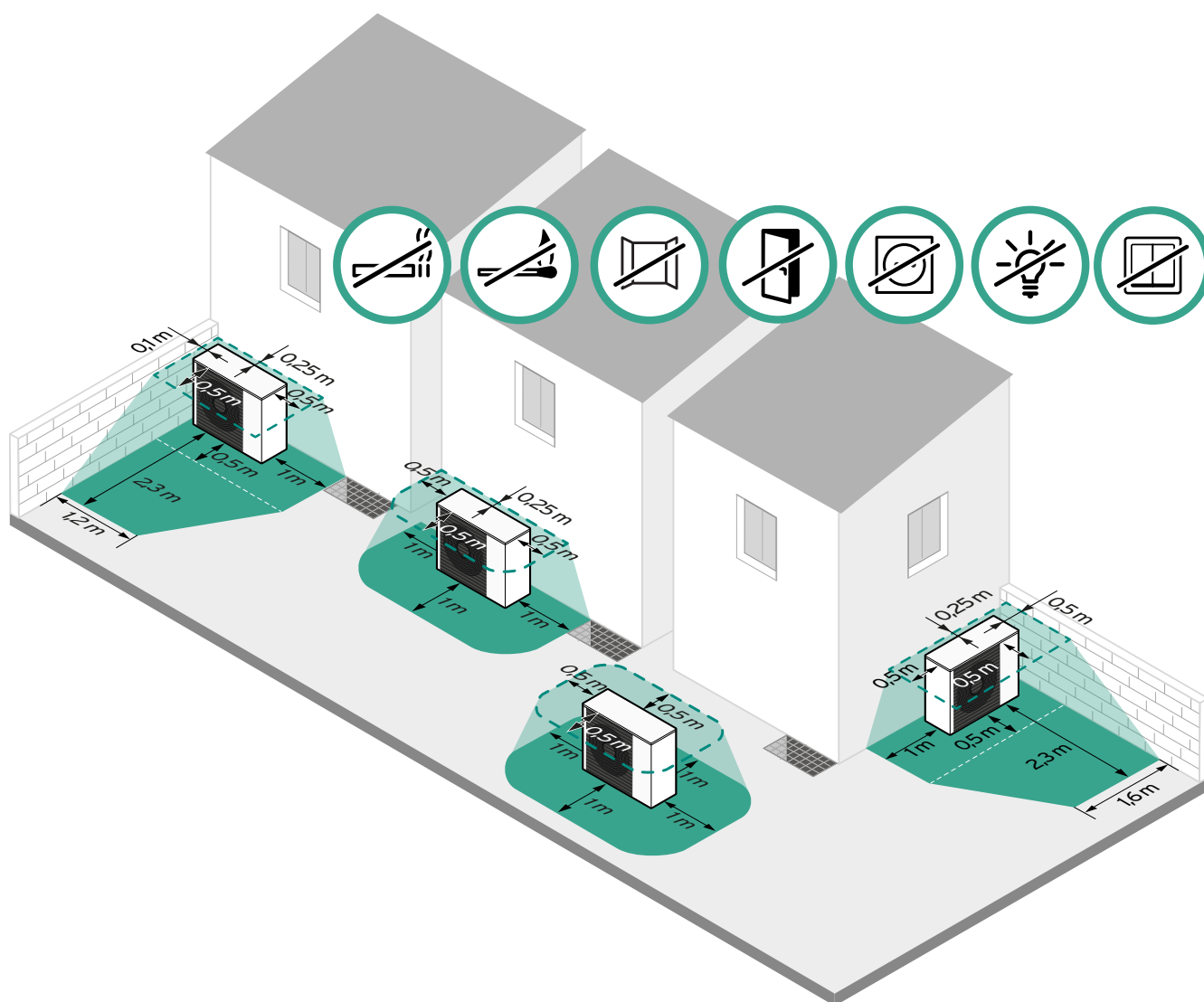

0020297937



 Voltar ao menu principal



## Um local arejado para um funcionamento perfeito

Sim! 

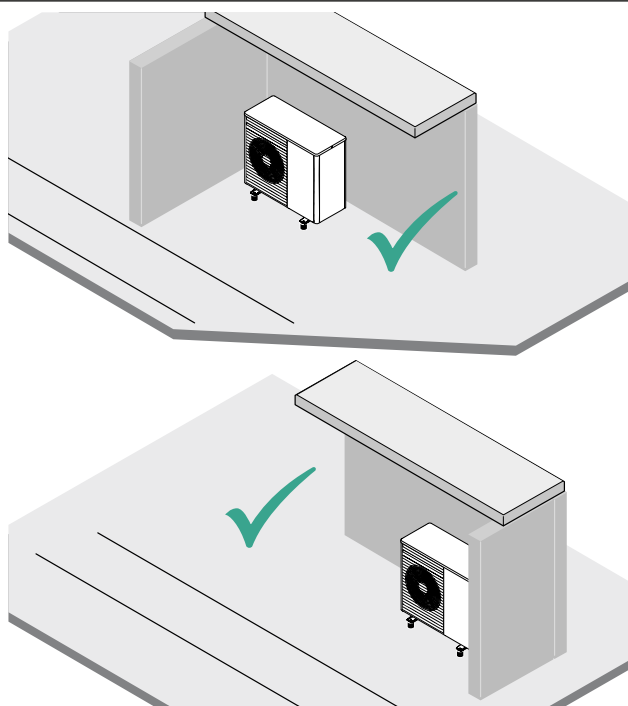

Não! 

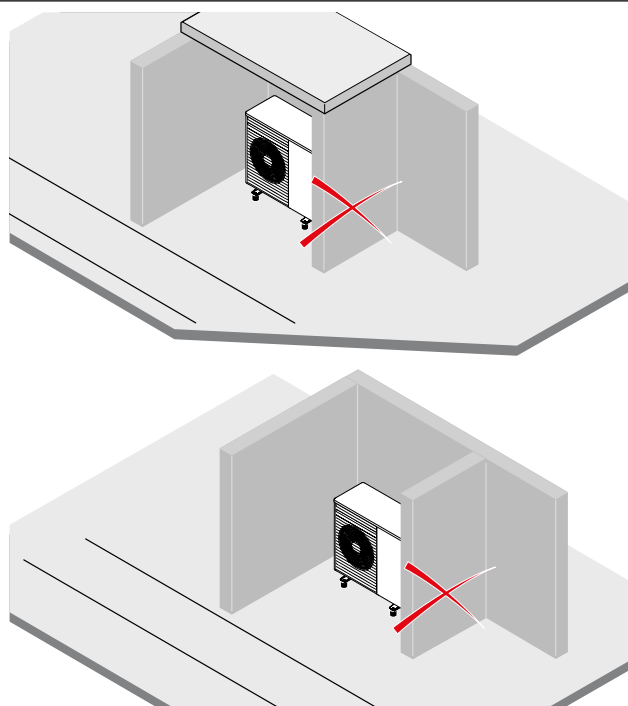

## Distâncias mínimas para funcionamento sem falhas

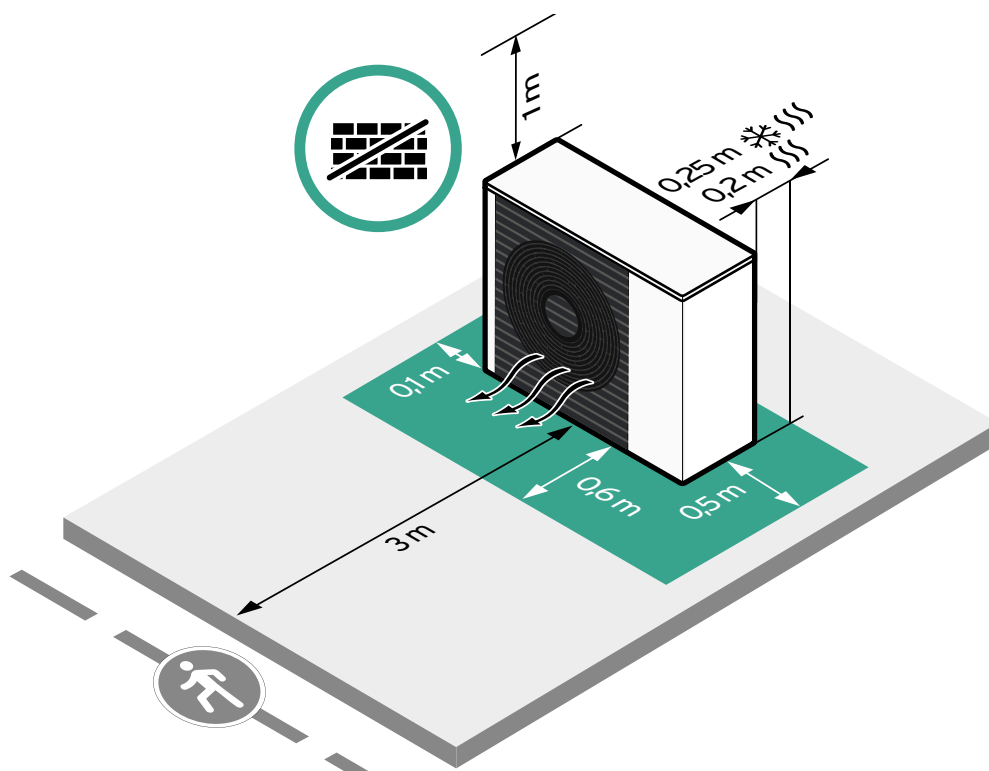

## Instalação de várias bombas de calor em cascata: local tranquilo, arejado e seguro!

Sim! 

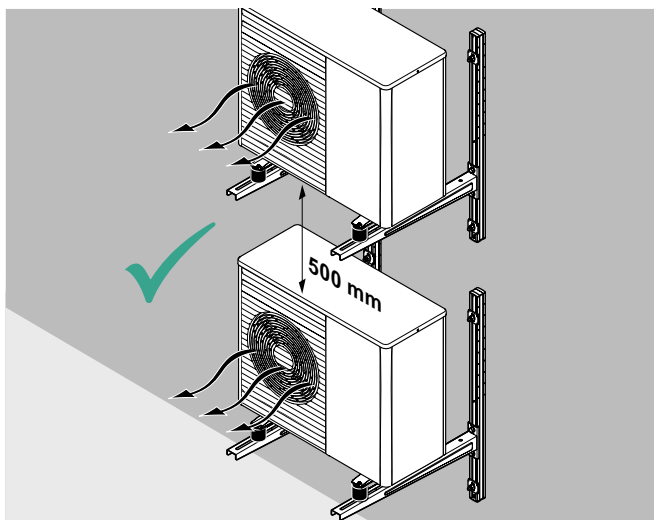
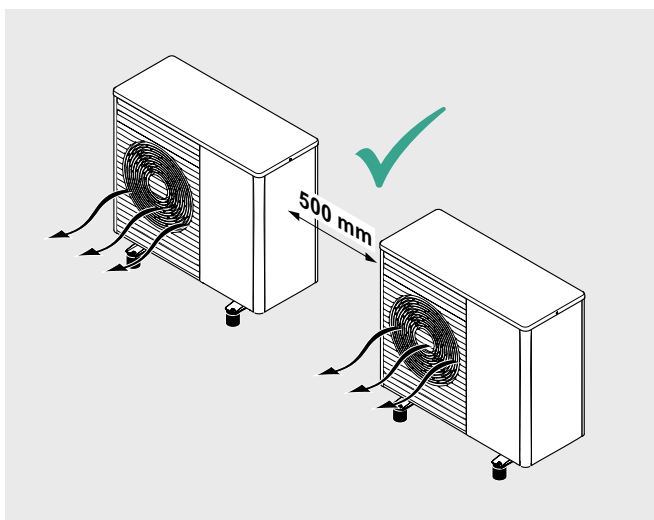

Não! 

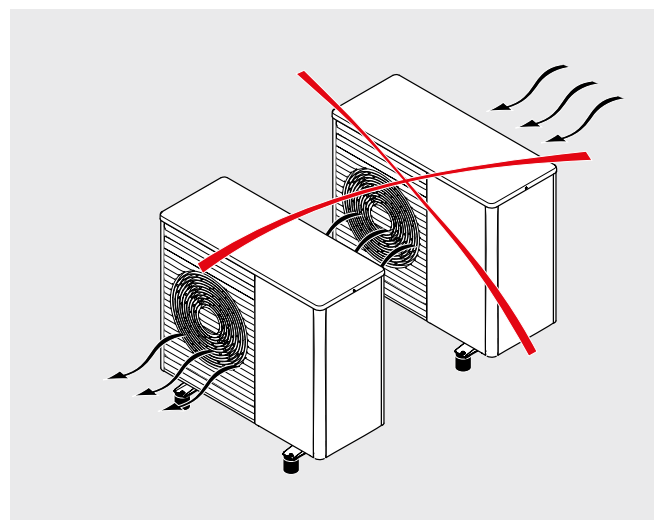
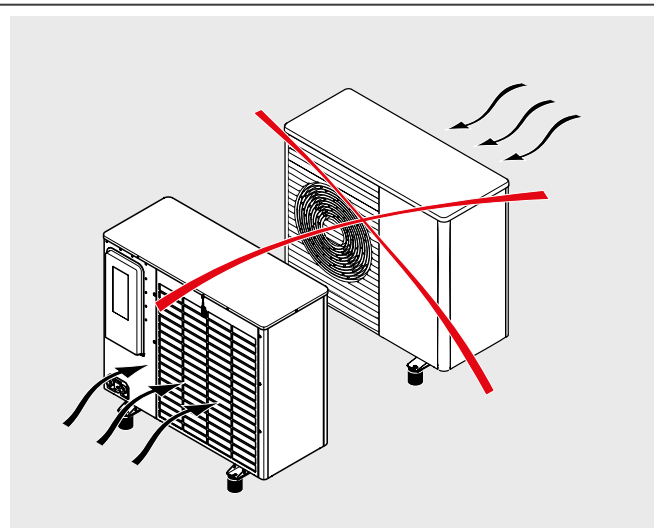

## Selecione o acumulador de AQS e o buffer

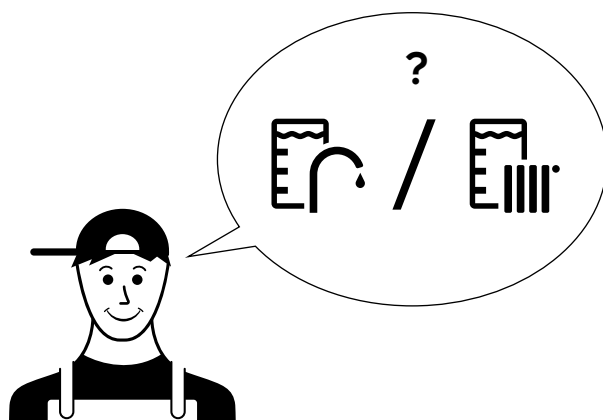
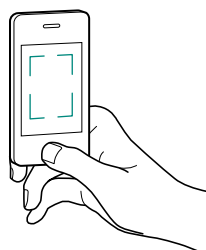

Digitalize o código QR para calcular rapidamente o volume do depósito de inércia necessário

Acumulador aquecido por...	... somente bomba de calor					... bomba de calor e sistema solar	
Acumulador	uniTOWER QW 190	uniSTOR VIH RW 200	uniSTOR VIH RW 300	uniSTOR VIH RW 400	uniSTOR VIH RW 500	uniSTOR VIH SW 400	uniSTOR VIH SW 500
Capacidade aquecida pela bomba de calor	190 l	200 l	300 l	400 l	500 l	200 l	250 l
Volume de água a 38 °C com 55 °C dentro do acumulador	305 l	321 l	482 l	643 l	804 l	321 l	402 l
<b>aroTHERM plus</b>	<b>Tempo de reaquecimento do acumulador a 55 °C, quando a temperatura estiver abaixo de 46 °C com 7 °C de temperatura exterior</b>						
VWL 45/6 S3	28 min	29 min	44 min	58 min *	73 min *	29 min	37 min
VWL 55/6 S3	28 min	29 min	44 min	58 min *	73 min *	29 min	37 min
VWL 65/6 S3	18 min	19 min	28 min	37 min	46 min	28 min	23 min
VWL 85/6 S3	18 min	19 min	28 min	37 min	46 min	28 min	23 min
VWL 125/6 S3	16 min	16 min	23 min	31 min	39 min	16 min	20 min
VWL 155/6 S3	16 min	16 min	23 min	31 min	39 min	16 min	20 min

\* Conforto limitado -> Recomendamos selecionar a aroTHERM plus na potência seguinte.

## Volume do depósito de inércia mínimo necessário / volume de água para função anti-congelamento

aroTHERM plus	Com resistência ativa, temperatura do sistema > 25 °C	Com resistência ativa, temperatura do sistema > 15 °C
VWL 45/6 S3, VWL 55/6 S3	15 l	40 l
VWL 65/6 S3, VWL 85/6 S3	20 l	55 l
VWL 125/6 S3, VWL 155/6 S3	45 l	150 l

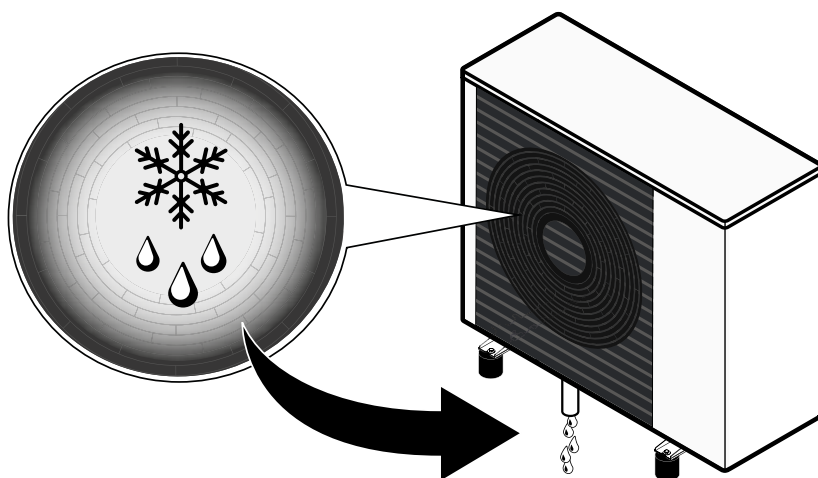

## Dimensionar o vaso de expansão

Digitalize o código QR para dimensionar facilmente o seu vaso de expansão

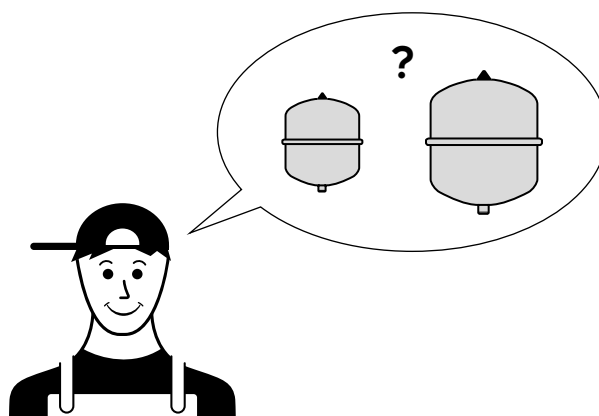
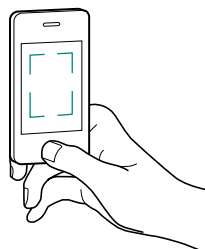

Digitalize o QR Code para obter as dimensões do vaso de expansão

## Perda de carga restante da bomba circuladora

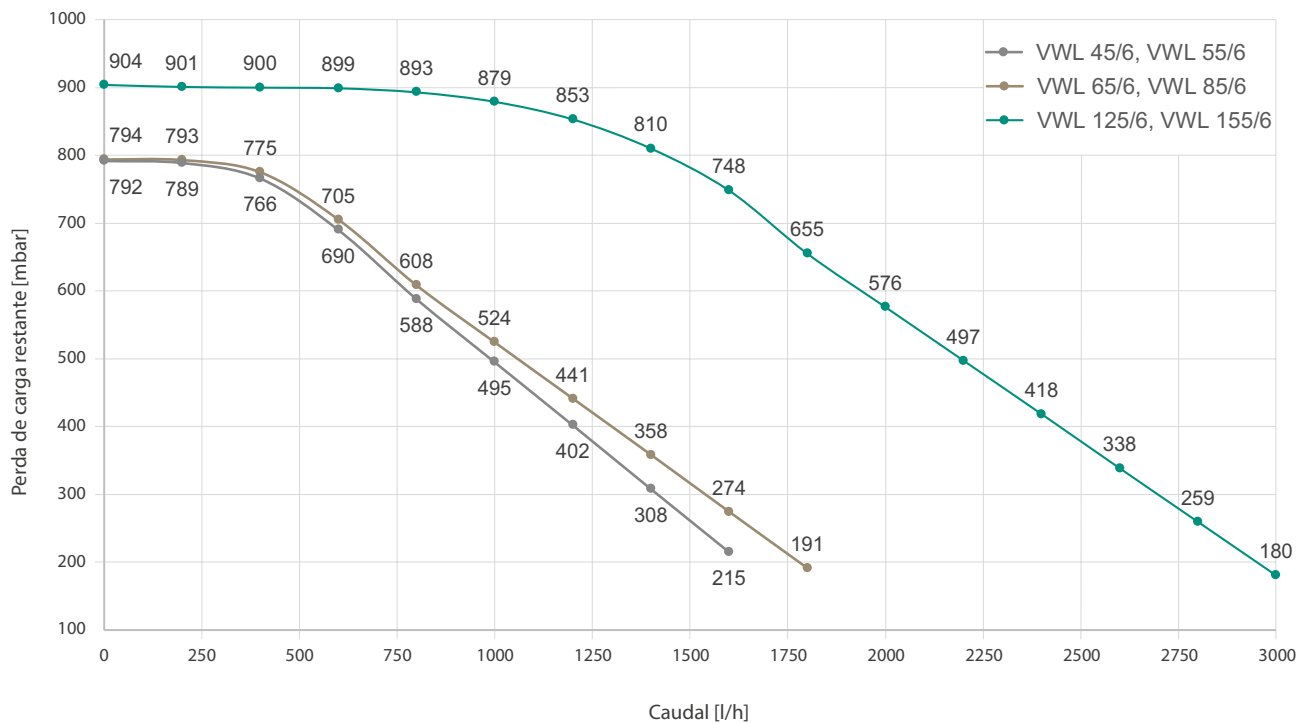

## Selecione o esquema do sistema (componentes do sistema, hidráulicos e electrónicos)

Digitalize o QR Code para seleccionar o esquema pretendido a partir da base de dados

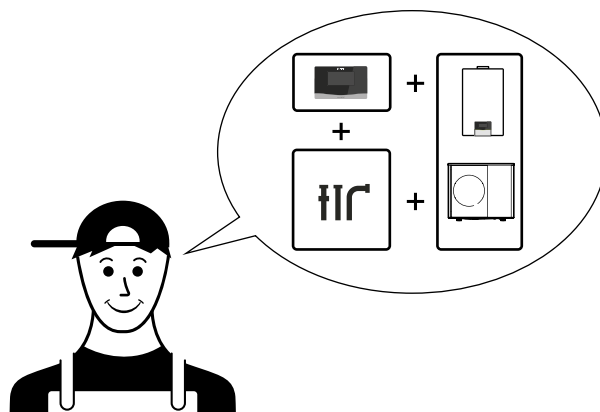
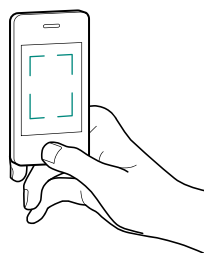

Digitalize o QR Code para seleccionar o esquema pretendido

## Decidir o tipo de instalação

### Na cobertura...

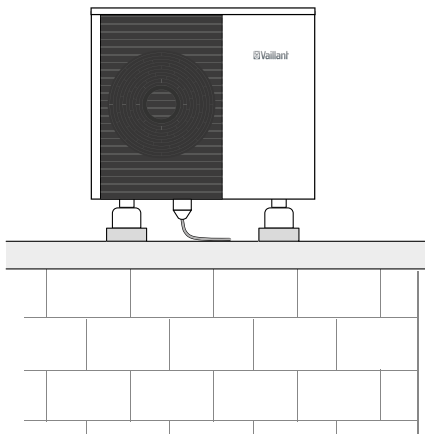

### Na parede...

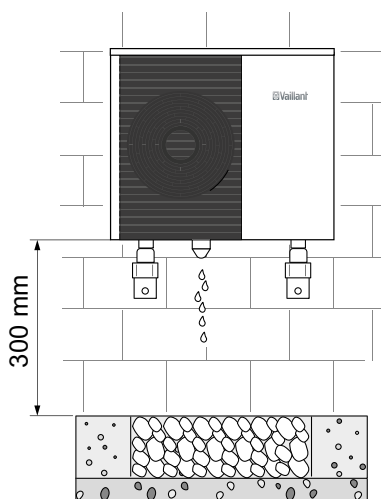

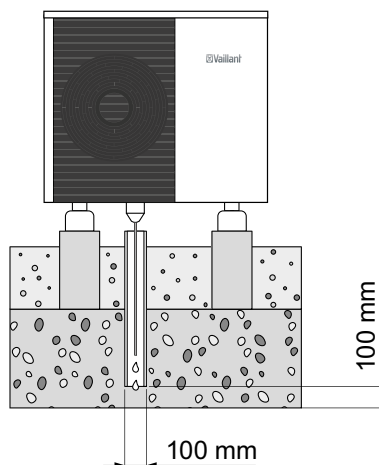

### No chão...

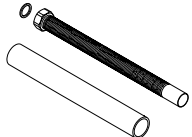

## Selecione os acessórios de montagem

Clique nas imagens para mais informações

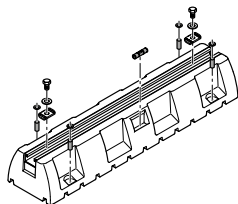
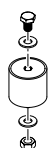
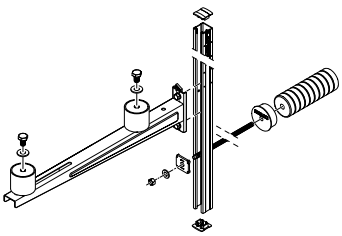
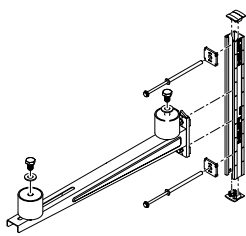
	Opções de instalação	
	Chão/Cobertura	Parede
<b>Conexão</b>		
<b>Plana</b>	<p><b>Kit de conexão de tubos planos</b> Referência: -No.: 0010027976</p> 	
<b>Roscada</b>	<p><b>Kit de conexão de tubos roscados</b> Referência: -No.: 0010027989</p> 	
<b>Montagem</b>		
<b>Simple</b>	<p><b>Sinoblocos</b> Referência: -No.: 0020250226</p> 	<p><b>Juntas anti-vibráteis</b> Referência: -No.: 0020252091</p> 
	<p><b>Suportes para paredes isoladas</b> Referência: -No.: 0020250224</p> 	<p><b>Suportes para paredes não-isoladas</b> Referência: -No.: 0020250225</p> 

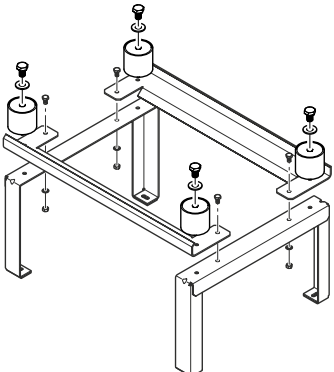
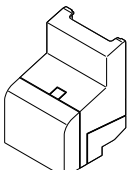
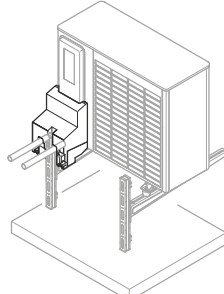
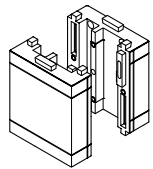
		Opções de instalação	
		Chão/Cobertura	Parede
<b>Montagem</b>			
<b>Neve</b>	<b>Espaçador de neve</b> Referência: -No.: 0010027984 		
<b>Isolamento dos tubos</b>			
<b>Simples</b>	<b>Kit de isolamento de chão em EPP</b> Referência: -No.: 0010027971 	<b>Kit de isolamento de parede em EPP</b> Referência: -No.: 0010027974 	
<b>Neve</b>	<b>Kit de extensão de chão em EPP</b> Referência: -No.: 0010027972 		





# Verifique o seu plano!

Use o seu check-list



- O cálculo da bomba de calor foi feito com base nas necessidades de aquecimento e arrefecimento
- O local da instalação foi planeado (tranquilo, ventilado e seguro)
- As temperaturas do sistema foram consideradas (piso radiante, radiadores e ventilo-convetores)
- O acumulador de AQS e o depósito de inércia foram escolhidos
- O vaso de expansão foi calculado
- O esquema do sistema foi escolhido
- Foram seleccionados os acessórios necessários



# ... execute o seu plano

Instale a aroTHERM plus.

Comece com a conexão hidráulica

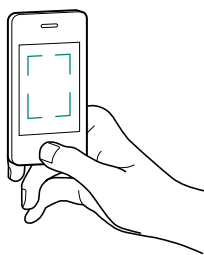

Digitalize ou clique em QR Code para um vídeo de instalação

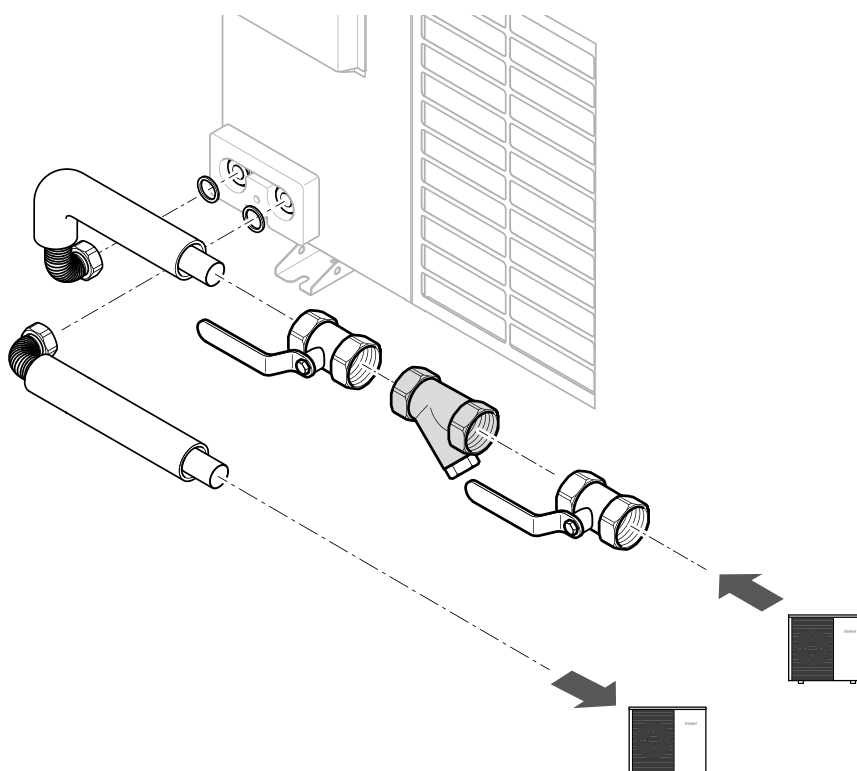

## Continue com a fonte de alimentação e a conexão eBUS

### Preparação

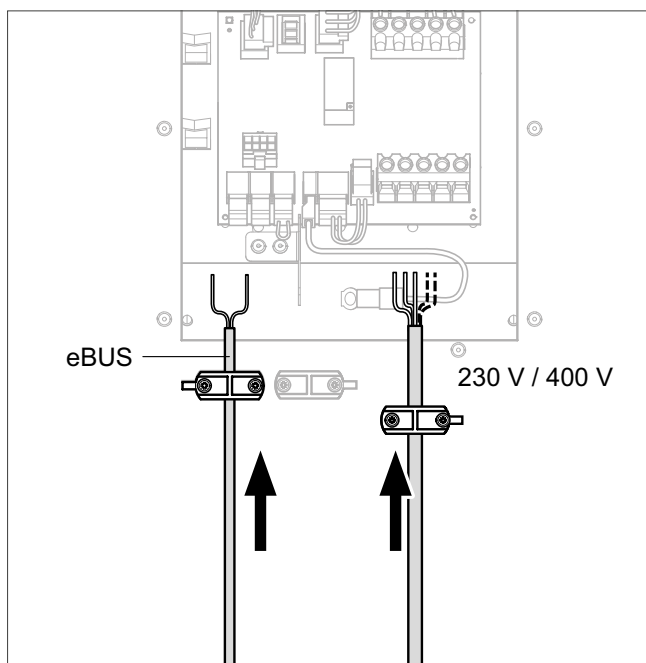
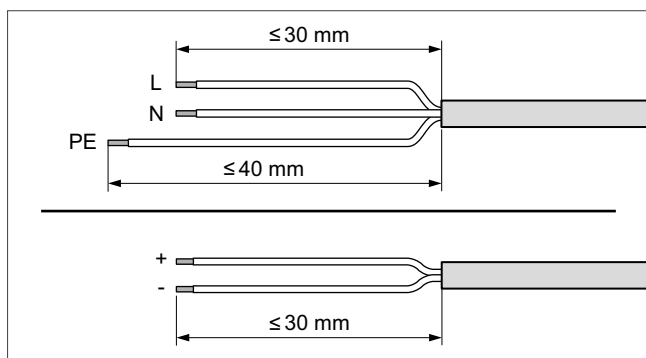
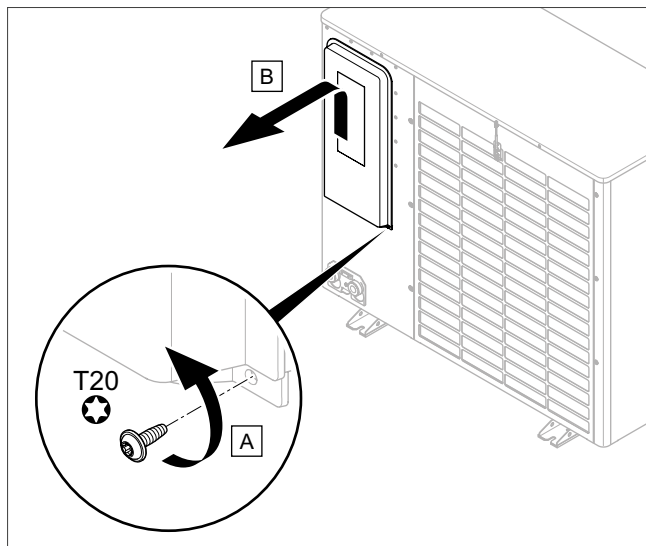

### Alimentação eléctrica (230 V ou 400 V)

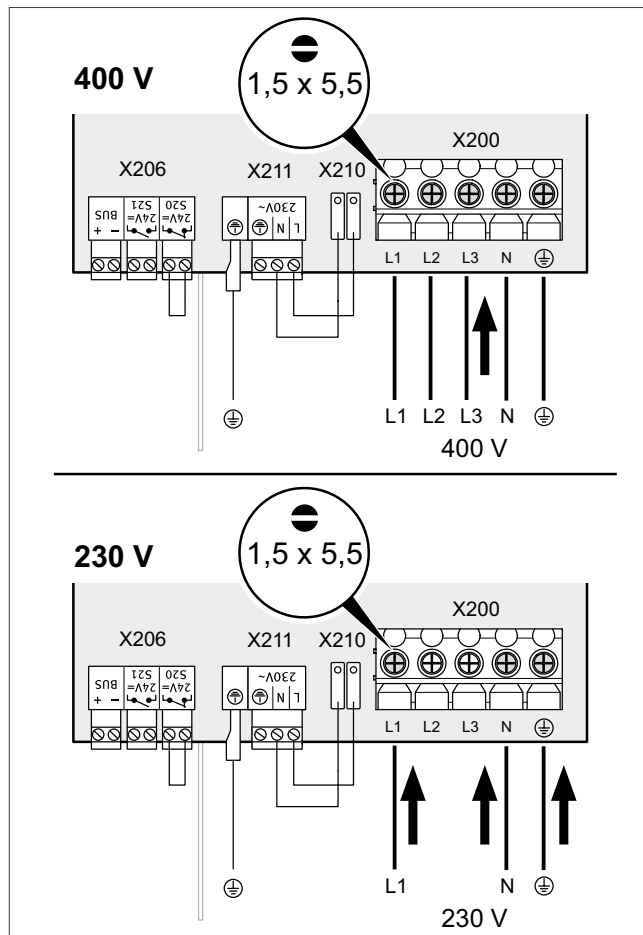

## Conexão eBUS

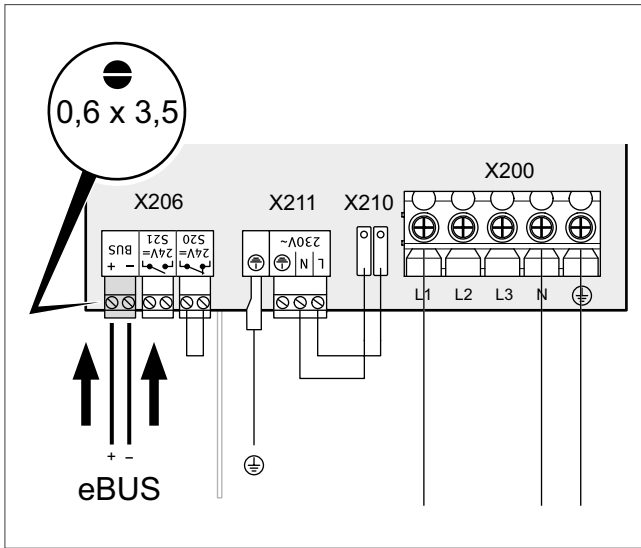

## Aperte a régua de tensão do cabos

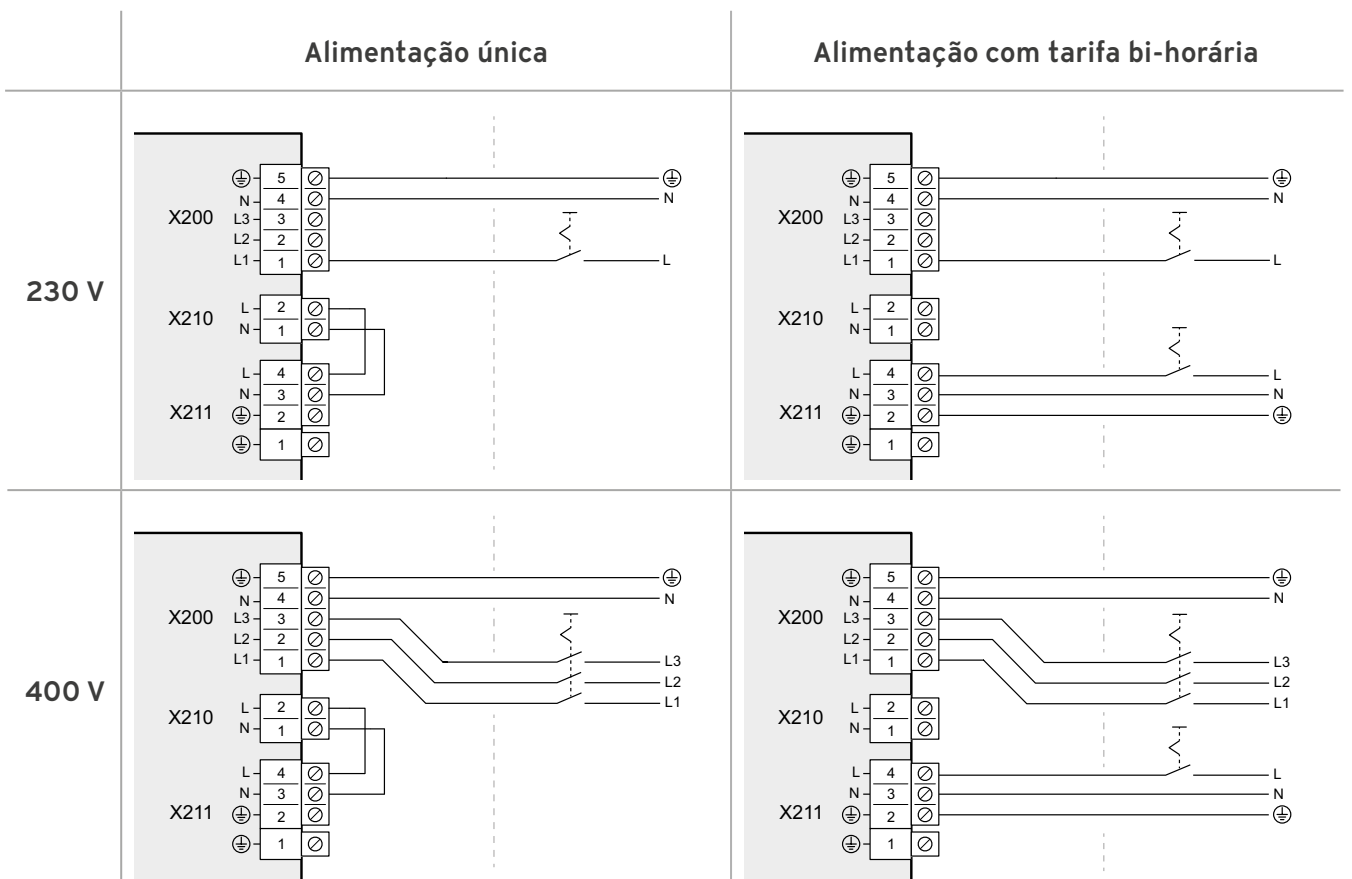
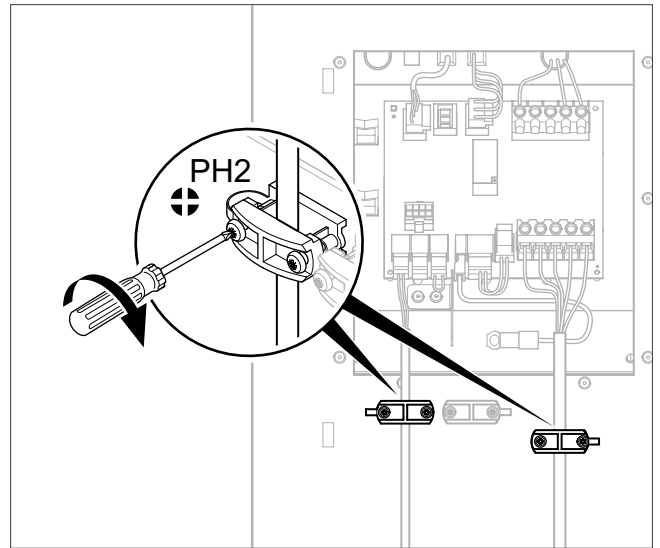

## Conecte a torre hidraulica - uniTOWER ou o MEH 97

### Instale a uniTOWER

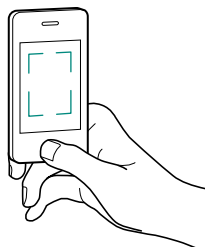



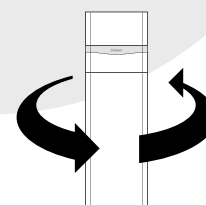
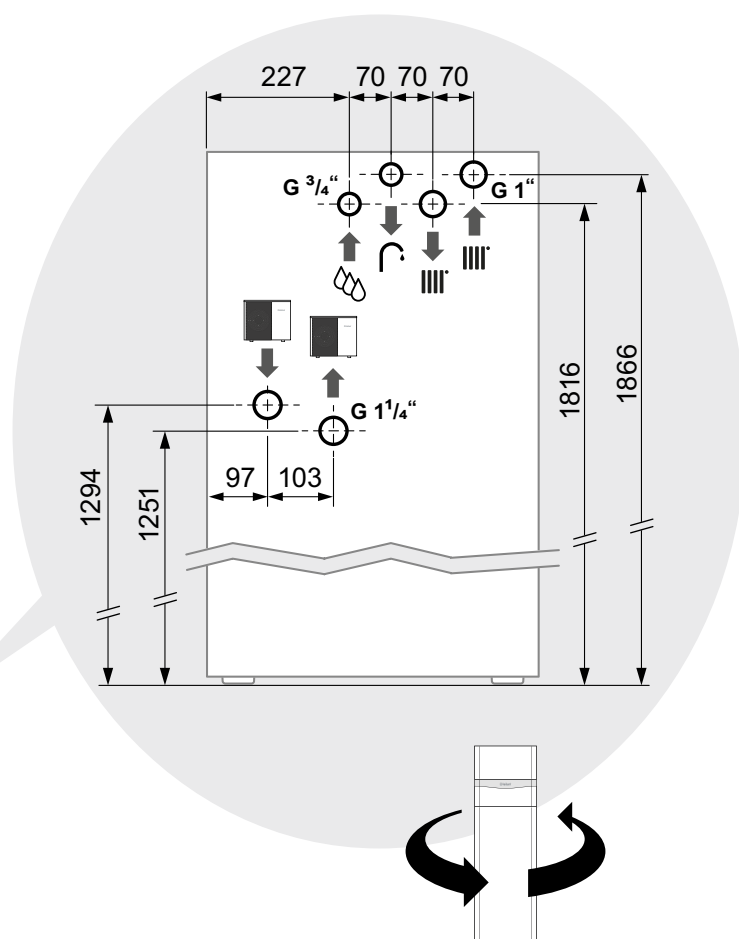
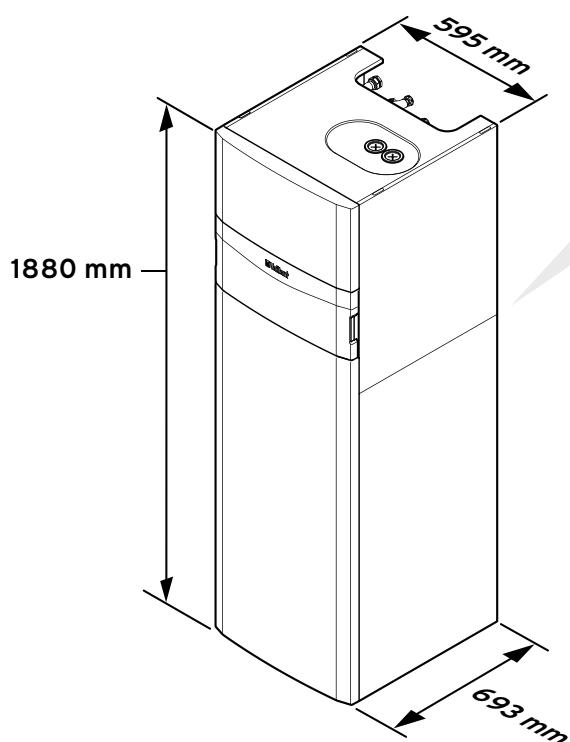







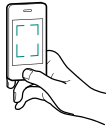

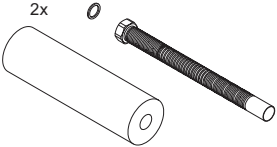
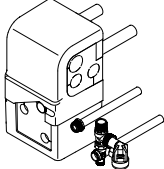
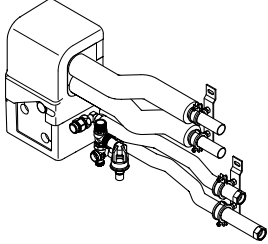

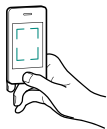

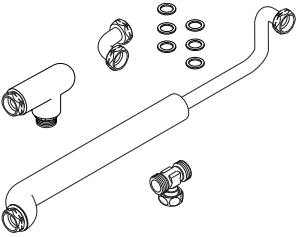
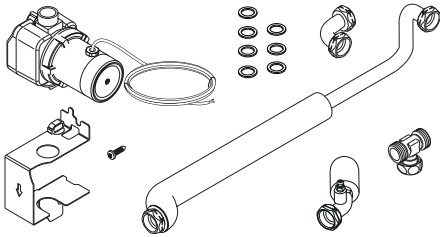
Digitalize ou clique em QR Code para aceder ao vídeo de instalação

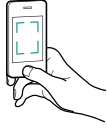

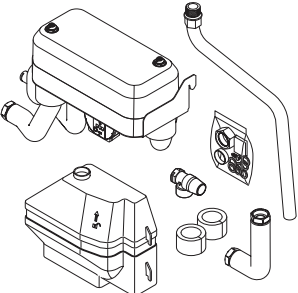
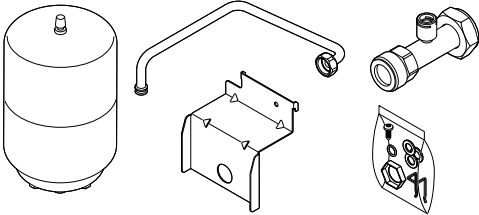
Clique nas imagens para mais informações

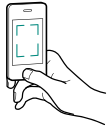

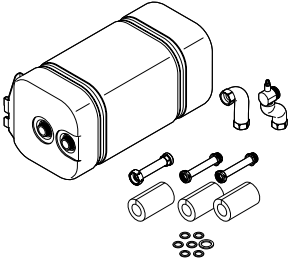
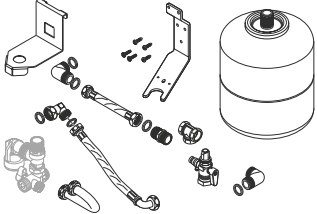
## Selecione os acessórios hidráulicos para a uniTOWER

Conexão...	à bomba de calor	ao circuito de aquecimento	
  <p><b>Digitalize ou clique no QR Code para ver o vídeo de instalação</b></p> 	<p><b>Kit de conexão uniTOWER</b> (circuito primário) Ref.: -No.: 0010027979</p> 	<p><b>Kit de conexão à parede</b> (10 bar) Ref.: -No.: 0020250220</p> 	<p><b>Kit de conexão na parede</b> (10 bar) Ref.: -No.: 0020250219</p> 
Circulação...	sem bomba circuladora	com bomba circuladora integrada	
  <p><b>Digitalize ou clique no QR Code para ver o vídeo de instalação</b></p> 	<p><b>Kit de re-circulação</b> Ref.: -No.: 0020170502</p> 	<p><b>Kit de re-circulação</b> Ref.: -No.: 0020170503</p> 	
Separação do sistema			
  <p><b>Digitalize ou clique no QR Code para ver o vídeo de instalação</b></p> 	<p><b>Módulo de desacoplamento uniTOWER</b> Ref.: -No.: 0010027973</p> 	<p><b>Vaso de expansão</b> Ref.: -No.: 0020218627</p> 	
Componentes adicionais do sistema			
  <p><b>Digitalize ou clique no QR Code para ver o vídeo de instalação</b></p> 	<p><b>Buffer de 18l para uniTOWER</b> Ref.: -No.: 0020269273</p> 	<p><b>Vaso de expansão (AQS), 8l</b> Ref.: -No.: 0020180979</p> 	<p><b>Válvula by-pass</b> Ref.: -No.: 0020059561</p> 

 Voltar ao menu principal

## Instalar o MEH 97

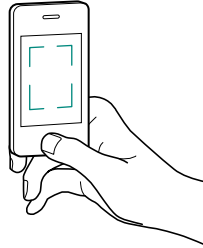

Digitalize ou clique no QR Code para ver o vídeo de instalação

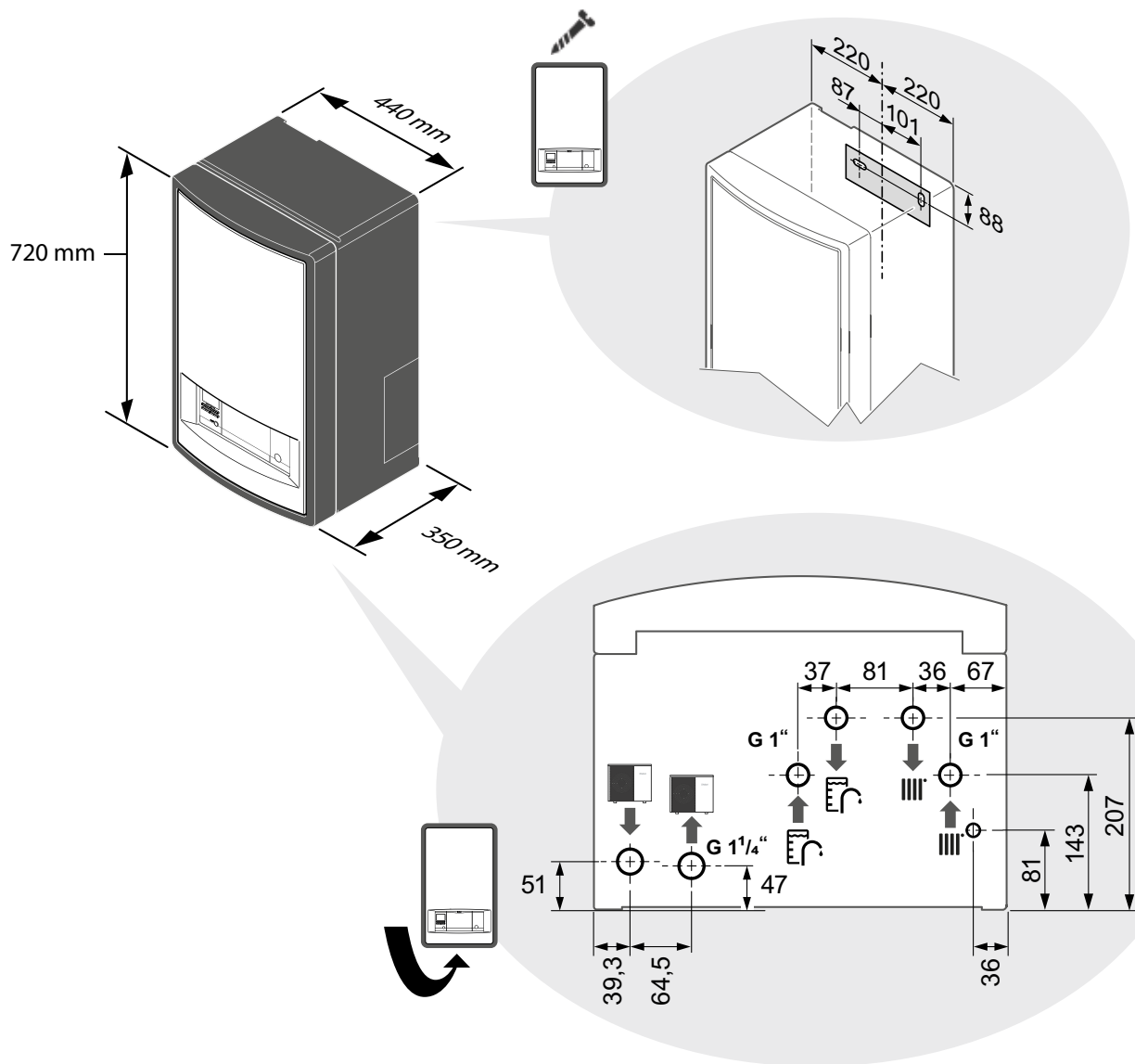

# Verifique o check-list!

Utilize o checklist de instalação 

- O local da instalação foi planeado (tranquilo, ventilad e seguro) e o tipo de instalação foi considerado (chão, parede, cobertura)
- Filtro de poeiras instalado no retorno
- Válvula de segurança instalada
- Vaso de expansão instalado
- Manómetro instalado
- Válvulas de serviço instaladas
- Conexões hidráulicas instaladas
- Conexão eléctrica efectuada
- Sistema de aquecimento pronto a funcionar



# ... vamos iniciar pela primeira vez o Sistema

Basta seguir as instruções do assistente de instalação no controlador VRC700 da aroTHERM plus .

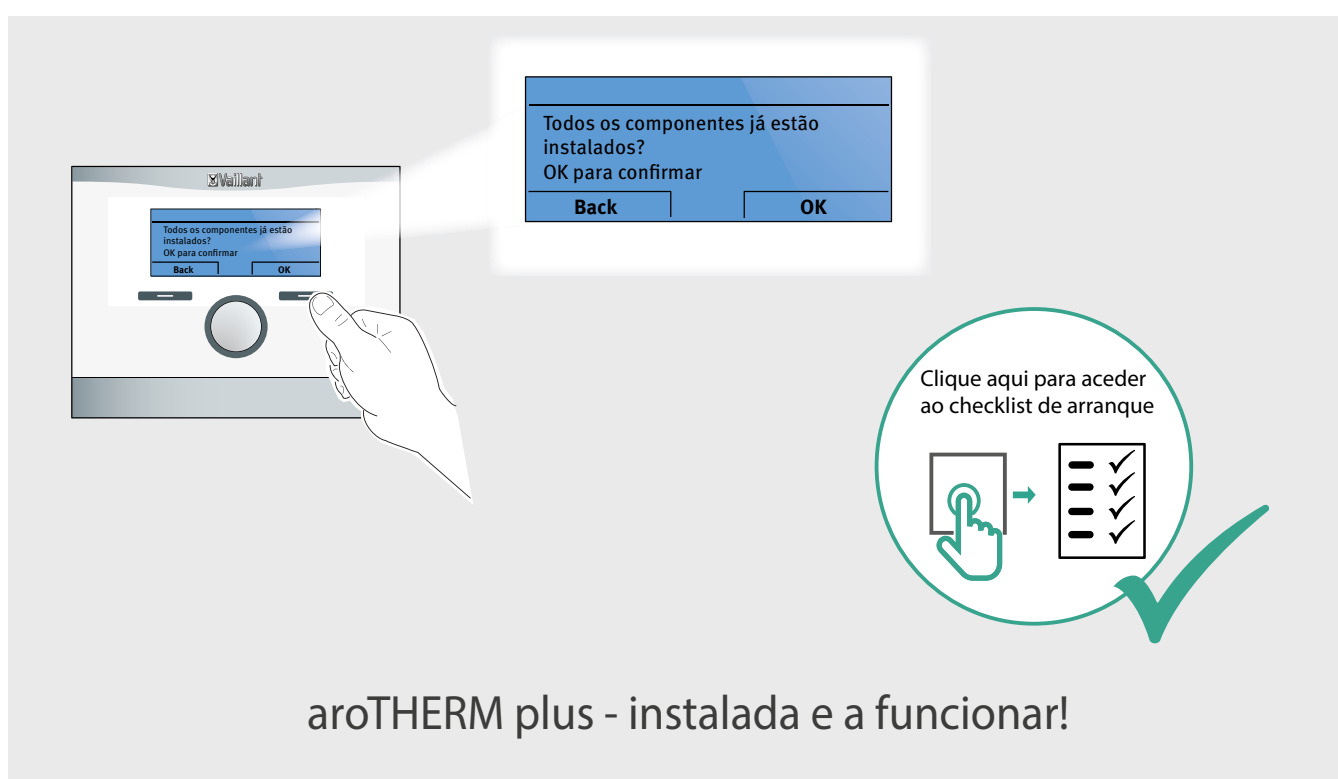

## Mas se por acaso ...

Veja aqui soluções para problemas, mensagens de erro, mensagens de estado e códigos de manutenção

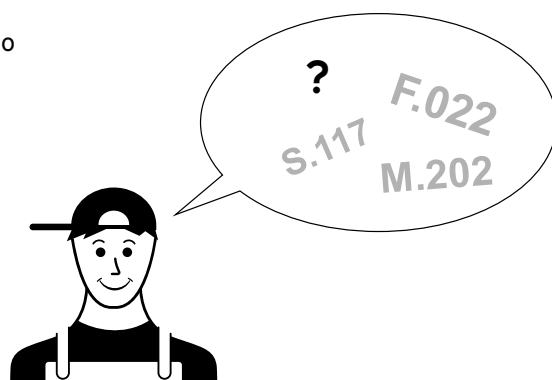
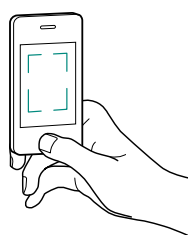

 Digitalize ou clique no QR code para solução de problemas

## Dados técnicos

aroTHERM plus	VWL 45/6 A S3	VWL 55/6 A S3	VWL 65/6 A S3	VWL 85/6 A S3	VWL 125/6 A S3	VWL 125/6 A S3	VWL 155/6 A S3	VWL 155/6 A S3
Alimentação eléctrica	230 V 1~/N/PE				230 V 1~/N/PE	400 V 3~/N/PE	230 V 1~/N/PE	400 V 3~/N/PE
Potência atribuída, máxima	3,40 kW		3,50 kW		5,40 kW	8,00 kW	5,40 kW	8,00 kW
Fator de potência	1							
Corrente máxima	14,3 A		15,0 A		23,3 A	15,0 A	23,3 A	15,0 A
Corrente de arranque	14,3 A		15,0 A		23,3 A	15,0 A	23,3 A	15,0 A
Tipo de proteção	IP 15 B							
<b>Circuito de aquecimento</b>								
Temperatura (mín/max)	20 ... 75 °C							
Máxima distância entre a unidade exterior e a interior	20 m							
Máxima diferença de altura entre a unidade exterior e a interior	15 m							
Pressão de funcionamento, mínima	0,05 MPa (0,50 bar)							
Pressão de funcionamento, máxima	0,30 MPa (3,00 bar)							
Caudal mínimo	400 l/h		540 l/h				995 l/h	
Caudal máximo	860 l/h		1205 l/h				2065 l/h	
Volume na unidade exterior	1,5 l		2,0 l				2,5 l	
Volume mínimo no circuito de aquecimento	40 l		40 l				60 l	
<b>Potência de aquecimento / arrefecimento</b>								
A-7/W35	4,00 kW	4,90 kW	6,00 kW	6,50 kW	10,20kW		11,30 kW	
A2/W35	1,90 kW	1,90 kW	3,10 kW	3,10 kW	5,60 kW		5,70 kW	
A7/W35	4,10 kW	4,20 kW	5,10 kW	7,80 kW	11,60 kW		14,30 kW	
A7/W45	3,10 kW	3,10 kW	4,20 kW	4,20 kW	8,10 kW		8,10 kW	
A7/W55	3,60 kW	4,80 kW	5,80 kW	7,60 kW	13,20 kW		14,20 kW	
A7/W65	4,50 kW	4,50 kW	6,30 kW	6,30 kW	11,40 kW		11,40 kW	
A35/W7 (arrefecimento)	5,20 kW	5,20 kW	7,20 kW	7,20 kW	12,10 kW		12,00 kW	
A35/W18 (arrefecimento)	4,50 kW	4,50 kW	6,40 kW	6,40 kW	10,90 kW		10,80 kW	
<b>Coefficiente de desempenho COP, EN 14511 (aquecimento) / índice de eficiência energética EER, EN 14511 (arrefecimento)</b>								
A-7/W35	2,9	2,4	3,0	2,5	2,8		2,4	
A2/W35	3,7	3,7	4,1	4,1	4,3		4,2	
A7/W35	4,6	4,4	4,7	4,4	4,7		4,3	
A7/W45	3,6	3,6	3,6	3,6	4,1		4,1	
A7/W55	2,8	2,8	2,9	2,9	2,9		2,8	
A7/W65	2,3	2,3	2,3	2,3	2,3		2,3	
A35/W7 (arrefecimento)	2,6	2,6	2,7	2,7	2,8		2,8	
A35/W18 (arrefecimento)	4,3	4,3	4,2	4,2	4,6		4,6	
<b>Potência consumida efetiva</b>								
A-7/W35	1,38 kW	2,04 kW	2,00 kW	2,60 kW	3,64 kW		4,71 kW	
A2/W35	0,51 kW	0,51 kW	0,76 kW	0,76 kW	1,30 kW		1,36 kW	
A7/W35	0,89 kW	0,95 kW	1,09 kW	1,77 kW	2,47 kW		3,33 kW	
A7/W45	0,86 kW	0,86 kW	1,17 kW	1,17 kW	1,98 kW		1,98 kW	
A7/W55	1,29 kW	1,71 kW	2,00 kW	2,62 kW	4,55 kW		5,07 kW	
A7/W65	1,96 kW	1,96 kW	2,74 kW	2,74 kW	4,96 kW		4,96 kW	
A35/W7 (arrefecimento)	2,00 kW	2,00 kW	2,67 kW	2,67 kW	4,32 kW		4,29 kW	
A35/W18 (arrefecimento)	1,05 kW	1,05 kW	1,52 kW	1,52 kW	2,37 kW		2,35 kW	
<b>Potência consumida</b>								
A-7/W35	6,80 A	9,30 A	9,40 A	11,60 A	16,40 A	6,10 A	20,90 A	7,60 A
A2/W35	2,60 A	2,60 A	3,70 A	3,70 A	6,20 A	2,90 A	6,70 A	2,70 A
A7/W35	4,20 A	4,50 A	5,20 A	8,00 A	11,20 A	4,40 A	15,10 A	5,60 A
A7/W45	4,00 A	4,00 A	5,40 A	5,40 A	9,40 A	3,60 A	9,40 A	3,60 A
A7/W55	6,30 A	7,70 A	9,40 A	11,70 A	20,10 A	7,30 A	22,50 A	8,10 A
A7/W65	9,00 A	9,00 A	12,20 A	12,20 A	22,20 A	7,90 A	22,20 A	7,90 A
A35/W7 (arrefecimento)	9,10 A	9,10 A	11,90 A	11,90 A	10,20 A	4,00 A	19,20 A	7,00 A
A35/W18 (arrefecimento)	4,90 A	4,90 A	7,00 A	7,00 A	10,90 A	4,20 A	10,90 A	4,20 A



## Dados técnicos - uniTOWER & VWZ MEH 97/6

	<b>VIH QW 190/6 E</b>	<b>VWZ MEH 97/6</b>
Alimentação eléctrica 230 V	230 V (+10%/-15%), 50 Hz, 1~/N/PE	230 V (+10%/-15%), 50 Hz, 1~/N/PE
Alimentação eléctrica 400 V	400 V (+10%/-15%), 50 Hz, 3~/N/PE	400 V (+10%/-15%), 50 Hz, 3~/N/PE
Potência atribuída, máxima	8,6 kW	8,6 kW
Corrente de medição, máxima, 230V	23,5 A	2,6 A
Corrente de medição, máxima, 400V	13,6 A	13,6 A
Capacidade de sobretensão	II	II



Bombas de calor ar-água • Bombas de calor reversíveis

0020305863 • Installer's Quick Guide • arOTHERM plus • 06/2020 • Technische und inhaltliche Änderungen vorbehalten • Angaben ohne Gewähr

Vaillant Group International GmbH  
- Sucursal em Portugal  
Av. Sidónio Pais, 379  
Edifício Hoechst, Salas 1.7-1.8  
4100-468 Porto

[www.vaillant.pt](http://www.vaillant.pt)  
[infor@vaillant.pt](mailto:infor@vaillant.pt)



**Vaillant**

Conforto para minha casa